



Feature -
small dimension
max. 8 positions

Application -
high value toy
power strip voltage selector
selection key on the application
AV machine, video recorder, air cleaner

► SPECIFICATIONS

SWITCH SPECIFICATIONS	
POLE - POSITION	1POLE , 2 POSITION~8 POSITION (STOP LESS) are Available
CONTACT RATING	0.5A 24V DC ; 0.2A 48V DC
CONTACT RESISTANCE	2 Ω MAX. 1.5 V DC ; 100 mA , by Method of Voltage DROP
INSULATION RESISTANCE	100 MΩ MIN. 500 V DC
DIELECTRIC STRENGTH	Breakdown is not Allowable ; 500 V AC for 1 Minute
OPERATING FORCE	400 ± 250 gf.cm 230 ± 100 gf.cm
OPERATING LIFE	2,000 cycles
OPERATING TEMPERATURE RANGE	-20°C ~ 70°C

► HOW TO ORDER

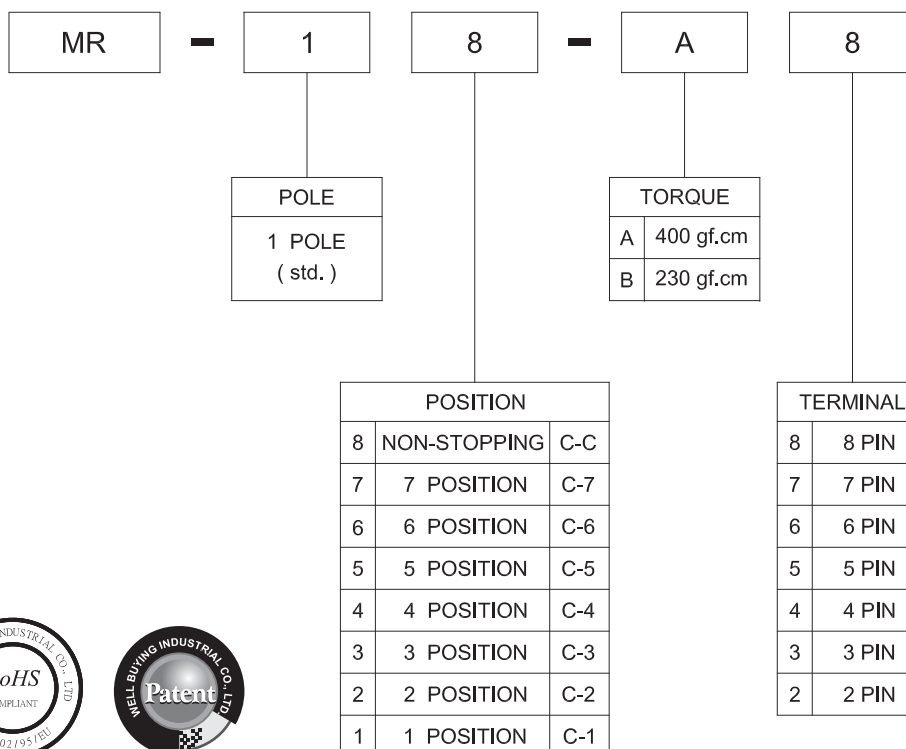

MR SERIES ROTARY SWITCH

▶ DIMENSION

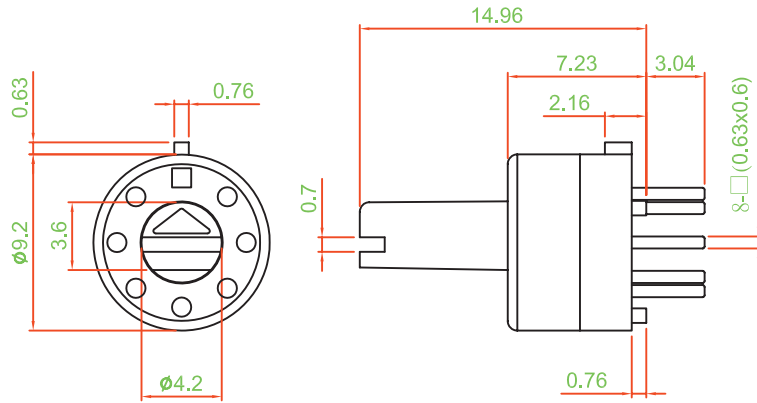

▶ MR - 18 - A8

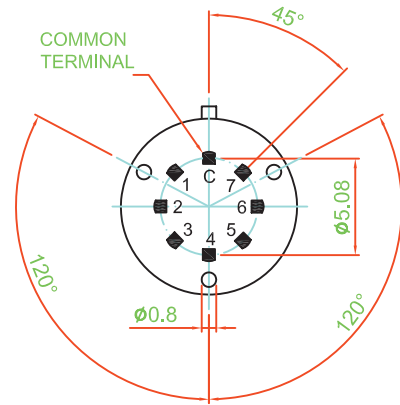

▶ OTHER ACTUATOR TYPE

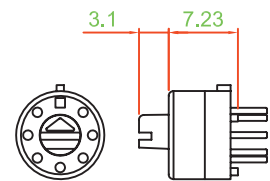
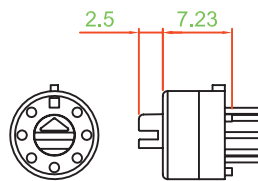
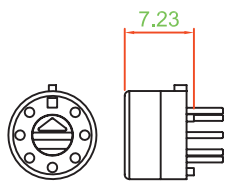

▶ SCHEMATIC

TRAVEL	SWITCHING POSITION
0°	C - C (OFF)
45°	C - 1
90°	C - 2
135°	C - 3
180°	C - 4
225°	C - 5
270°	C - 6
315°	C - 7

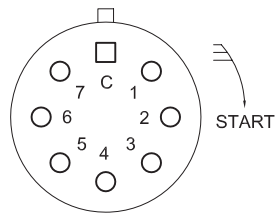

▶ P.C.B. LAYOUT

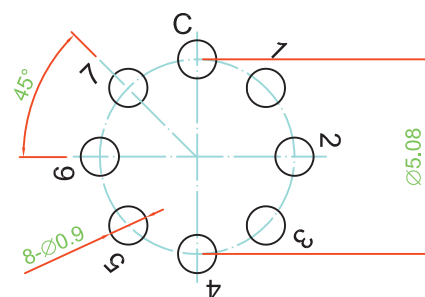

▶ UNIT WEIGHT

■ MR-18-A8 : 0.8 ± 0.05 g / pc

▶ MATERIAL

- FRAME : PA + GF
- SHAFT : PA + GF
- TERMINAL : BRASS GOLD PLATING